



Features

- Split Gate Trench MOSFET technology
- Excellent package for heat dissipation
- High density cell design for low $R_{DS(ON)}$

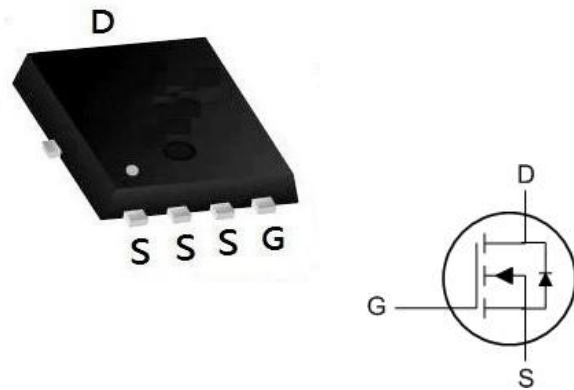
Product Summary

BVDSS	RDSON	ID
30V	0.5mΩ	280A

Applications

- DC-DC Converters
- Power management functions
- Synchronous-rectification applications

PDFN5060-8L Pin Configuration



Absolute Maximum Ratings

Symbol	Parameter	Rating	Units
V_{DS}	Drain-Source Voltage	30	V
V_{GS}	Gate-Source Voltage	± 20	V
$I_D@T_C=25^\circ C$	Continuous Drain Current, $V_{GS} @ 10V^{1,6}$	280	A
$I_D@T_C=100^\circ C$	Continuous Drain Current, $V_{GS} @ 10V^{1,6}$	177	A
I_{DM}	Pulsed Drain Current ²	1120	A
EAS	Single Pulse Avalanche Energy ³	1332	mJ
I_{AS}	Avalanche Current	---	A
$P_D@T_C=25^\circ C$	Total Power Dissipation ⁴	166.6	W
T_{STG}	Storage Temperature Range	-55 to 150	$^\circ C$
T_J	Operating Junction Temperature Range	-55 to 150	$^\circ C$

Thermal Data

Symbol	Parameter	Typ.	Max.	Unit
$R_{\theta JA}$	Thermal Resistance Junction-Ambient ¹	---	50	$^\circ C/W$
$R_{\theta JC}$	Thermal Resistance Junction-Case ¹	---	0.78	$^\circ C/W$

Electrical Characteristics ($T_J=25\text{ }^\circ\text{C}$, unless otherwise noted)

Symbol	Parameter	Conditions	Min.	Typ.	Max.	Unit
BV_{DSS}	Drain-Source Breakdown Voltage	$V_{GS}=0V, I_D=250\mu A$	30	---	---	V
$\Delta BV_{DSS}/\Delta T_J$	BV_{DSS} Temperature Coefficient	Reference to 25°C , $I_D=1\text{mA}$	---	---	---	$V/^\circ\text{C}$
$R_{DS(ON)}$	Static Drain-Source On-Resistance ²	$V_{GS}=10V, I_D=15A$	---	0.5	0.7	m Ω
		$V_{GS}=4.5V, I_D=5A$	---	0.7	1	
$V_{GS(th)}$	Gate Threshold Voltage	$V_{GS}=V_{DS}, I_D=-250\mu A$	1.2	1.6	2.2	V
$\Delta V_{GS(th)}$	$V_{GS(th)}$ Temperature Coefficient		---	---	---	$\text{mV}/^\circ\text{C}$
I_{DSS}	Drain-Source Leakage Current	$V_{DS}=30V, V_{GS}=0V, T_J=25^\circ\text{C}$	---	---	1	μA
		$V_{DS}=30V, V_{GS}=0V, T_J=100^\circ\text{C}$	---	---	100	
I_{GSS}	Gate-Source Leakage Current	$V_{GS}=\pm 20V, V_{DS}=0V$	---	---	± 100	nA
g_{fs}	Forward Transconductance	$V_{DS}=10V, I_D=15A$	---	130	---	S
R_g	Gate Resistance	$V_{DS}=0V, V_{GS}=0V, f=1\text{MHz}$	---	1.35	---	Ω
Q_g	Total Gate Charge	$V_{DS}=15V, V_{GS}=10V, I_D=15A$	---	147.4	---	nC
Q_{gs}	Gate-Source Charge		---	25.2	---	
Q_{gd}	Gate-Drain Charge		---	18	---	
$T_{d(on)}$	Turn-On Delay Time	$V_{GS}=10V, V_{DD}=15V,$ $R_G=3\Omega, I_D=15A$	---	12	---	ns
T_r	Rise Time		---	12.5	---	
$T_{d(off)}$	Turn-Off Delay Time		---	85	---	
T_f	Fall Time		---	39	---	
C_{iss}	Input Capacitance	$V_{DS}=15V, V_{GS}=0V, f=1\text{MHz}$	---	7304	---	pF
C_{oss}	Output Capacitance		---	2688	---	
C_{rss}	Reverse Transfer Capacitance		---	240	---	

Diode Characteristics

Symbol	Parameter	Conditions	Min.	Typ.	Max.	Unit
I_S	Continuous Source Current ^{1,4}	$V_G=V_D=0V$, Force Current	---	---	280	A
V_{SD}	Diode Forward Voltage ²	$V_{GS}=0V, I_S=15A, T_J=25^\circ\text{C}$	---	---	1.2	V
t_{rr}	Reverse Recovery Time	$I_F=15A, di/dt=100A/\mu\text{s}$,	---	120	---	nS
Q_{rr}	Reverse Recovery Charge	$T_J=25^\circ\text{C}$	---	60	---	nC

Notes:

1. Repetitive rating, pulse width limited by junction temperature $T_{J(MAX)}=150^\circ\text{C}$.
2. The test condition is $V_{DD}=40V, V_{GS}=10V, L=0.5\text{mH}, I_{AS}=73A$.
3. The data tested by surface mounted on a 1 inch² FR-4 board with 2OZ copper, The value in any given application depends on the user's specific board design.
4. The data tested by pulsed, pulse width $\leq 300\mu\text{s}$, duty cycle $\leq 2\%$.
5. This value is guaranteed by design hence it is not included in the production test..

Typical Characteristics

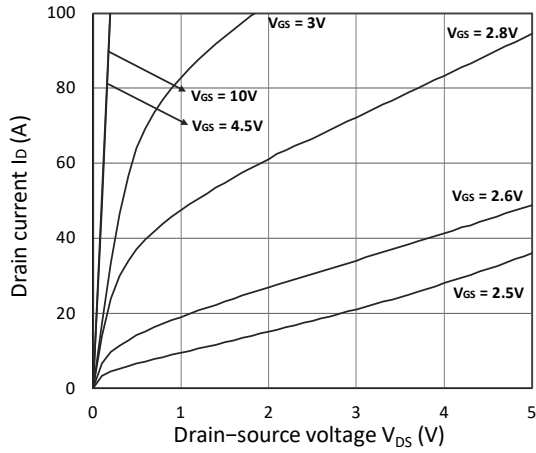


Figure 1. Output Characteristics

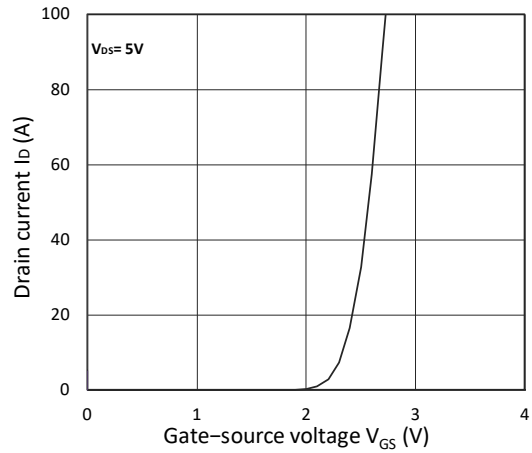


Figure 2. Transfer Characteristics

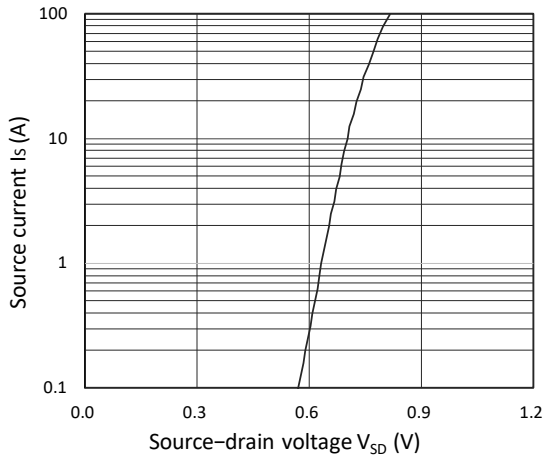


Figure 3. Forward Characteristics of Reverse

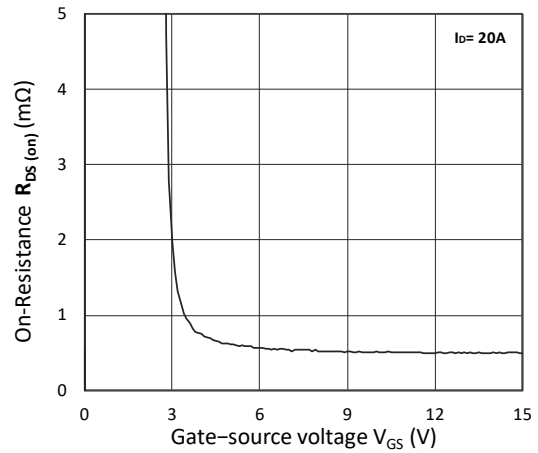


Figure 4. $R_{DS(ON)}$ vs. V_{GS}

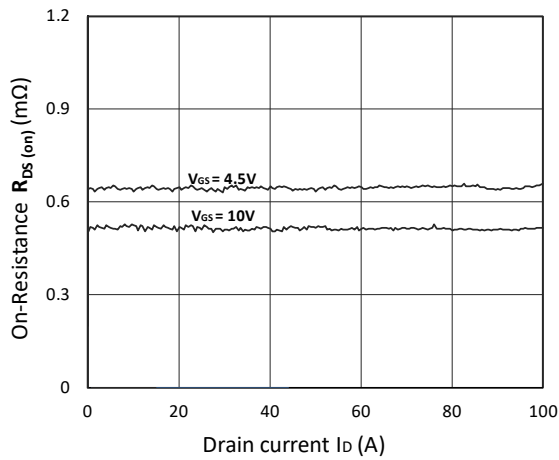


Figure 5. $R_{DS(ON)}$ vs. I_D

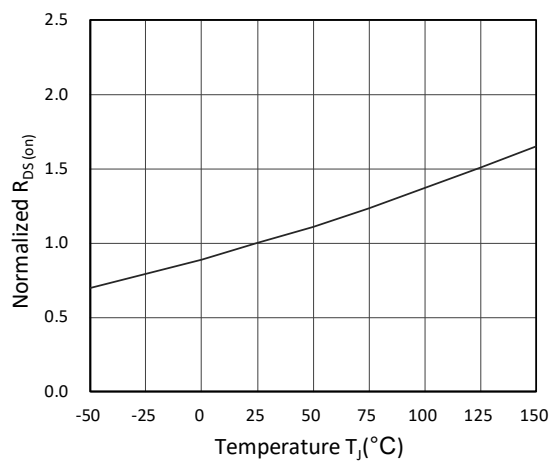


Figure 6. Normalized $R_{DS(ON)}$ vs. Temperature

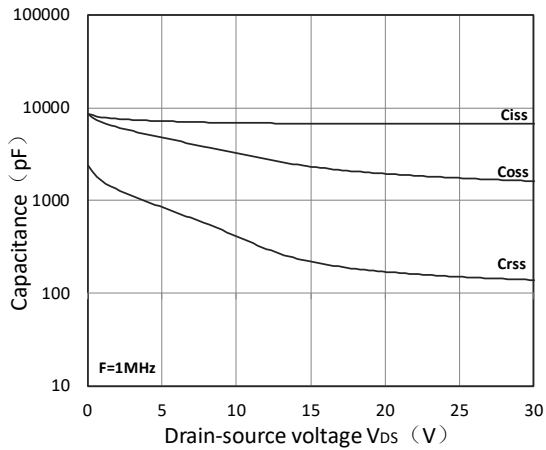
N-Ch 30V Fast Switching MOSFETs


Figure 7. Capacitance Characteristics

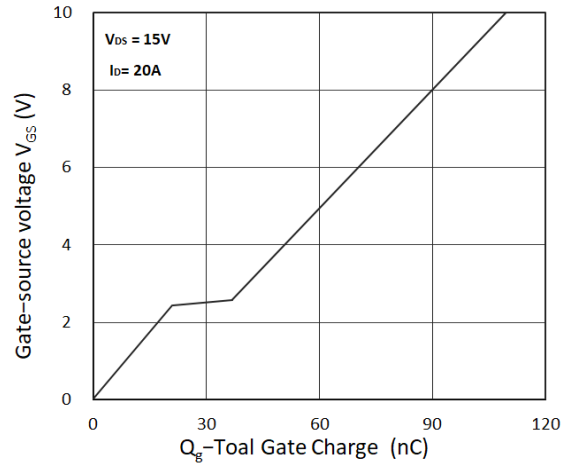


Figure 8. Gate Charge Characteristics

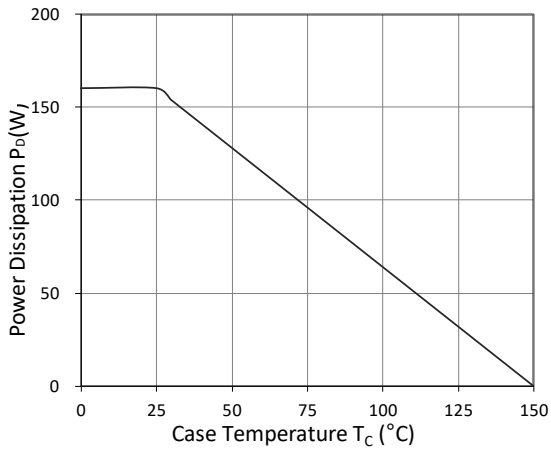


Figure 9. Power Dissipation

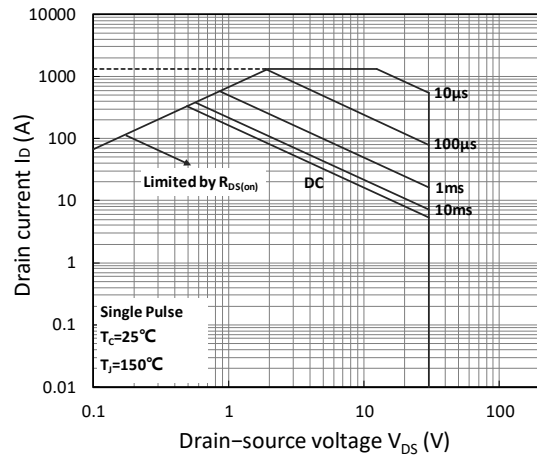


Figure 10. Safe Operating Area

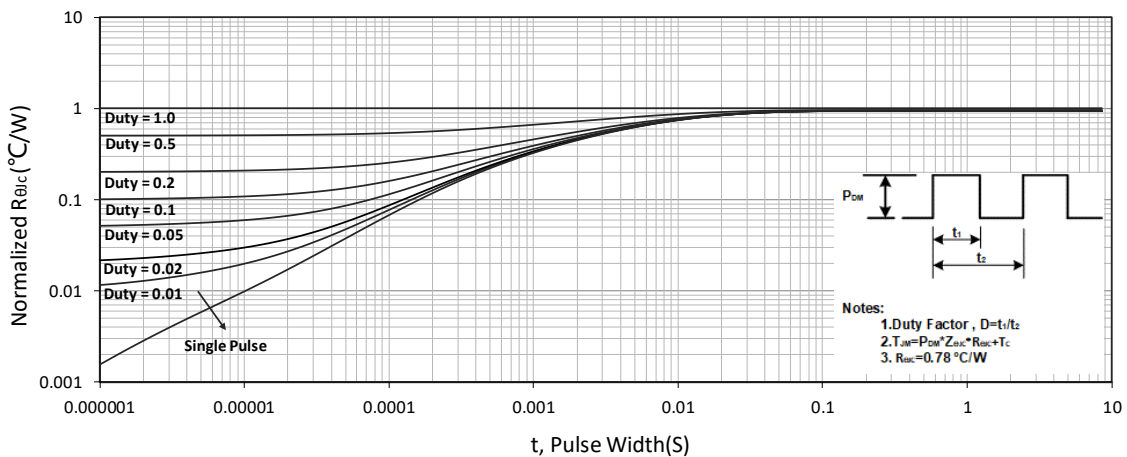


Figure 11. Normalized Maximum Transient Thermal Impedance

Test Circuit

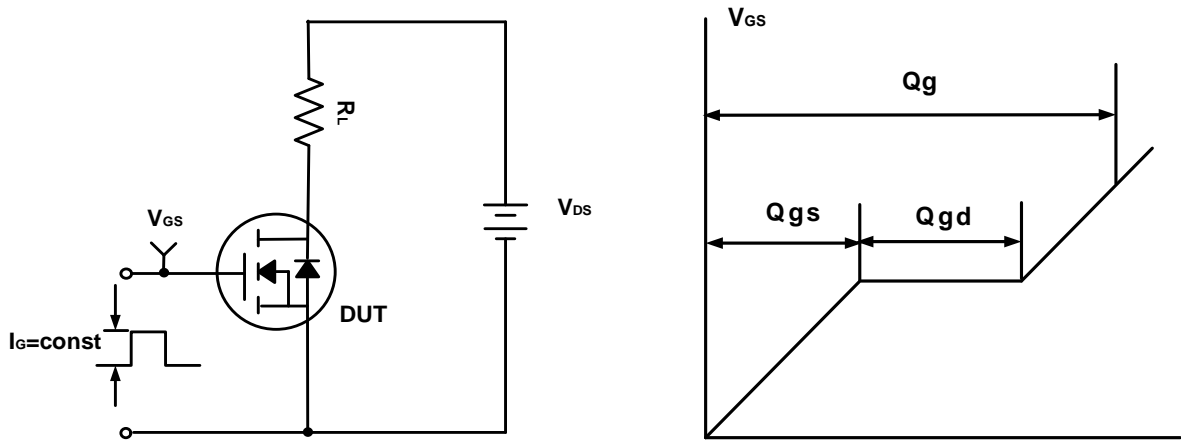


Figure A. Gate Charge Test Circuit & Waveforms

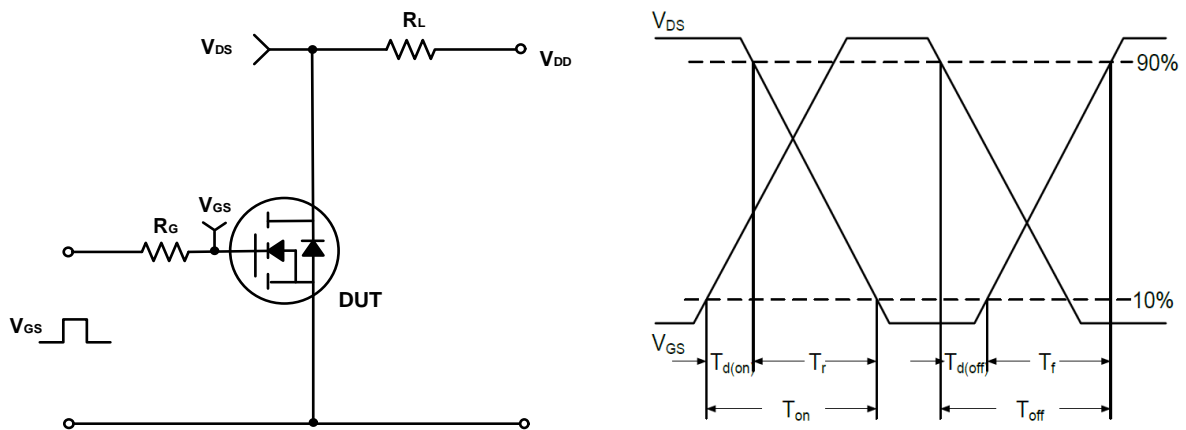


Figure B. Switching Test Circuit & Waveforms

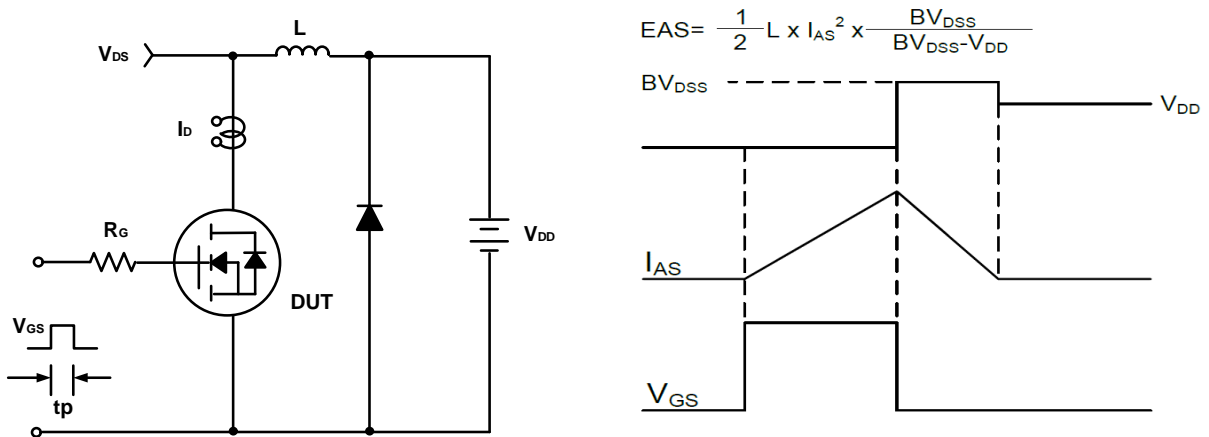
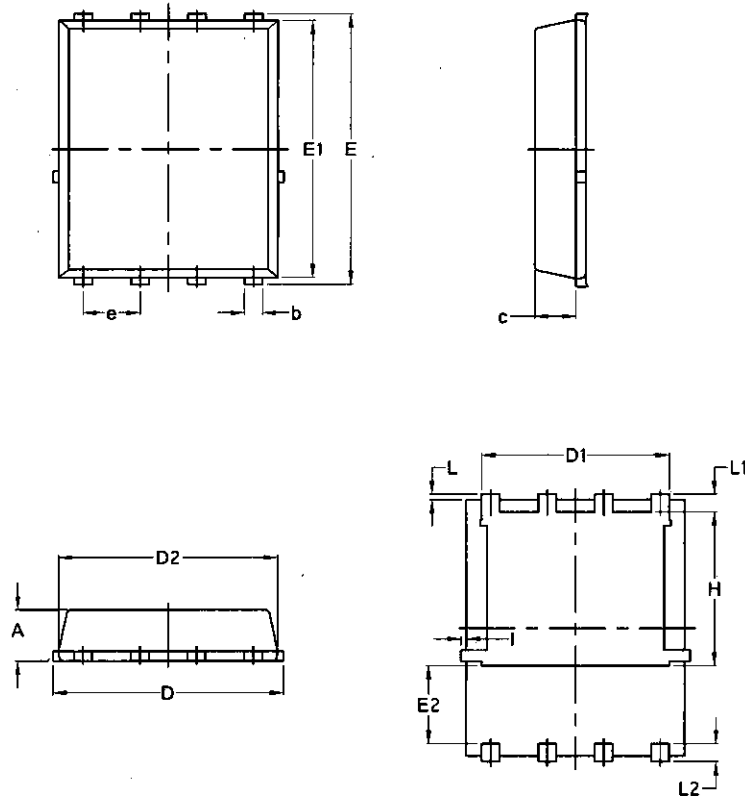


Figure C. Unclamped Inductive Switching Circuit & Waveforms

Package Mechanical Data-PDFN5060-8L-Single


Symbol	Common			
	mm		Inch	
	Min	Max	Min	Max
A	1.03	1.17	0.0406	0.0461
b	0.34	0.48	0.0134	0.0189
c	0.824	0.0970	0.0324	0.082
D	4.80	5.40	0.1890	0.2126
D1	4.11	4.31	0.1618	0.1697
D2	4.80	5.00	0.1890	0.1969
E	5.95	6.15	0.2343	0.2421
E1	5.65	5.85	0.2224	0.2303
E2	1.60	/	0.0630	/
e	1.27 BSC		0.05 BSC	
L	0.05	0.25	0.0020	0.0098
L1	0.38	0.50	0.0150	0.0197
L2	0.38	0.50	0.0150	0.0197
H	3.30	3.50	0.1299	0.1378
l	/	0.18	/	0.0070